



STEELER

SOKÓŁKA

www.steeler.pl

VOLKSWAGEN T5



INSTRUKCJA MONTAŻU

(Orurowania przednie –rura pod zderzak)

FITTING INSTRUCTION

(Front bullbar)

ИНСТРУКЦИЯ МОНТАЖА

(Кенгурин)

MONTAGEANLEITUNG

(Frontschutzbügel)

T5-R0070-05



Orurowania z homologacją „e”

Bullbar with homologation „e”

Тюнинг с омологацией „e”

Frontschutzbügel mit „e“- Prüfzeichen

Wykaz elementów orurowania:**Specification of full assembly:****Список элементов тюнинга:****Liste der Elemente:**

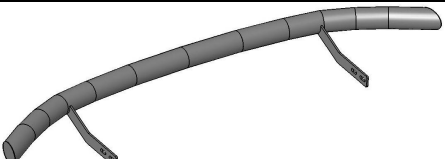
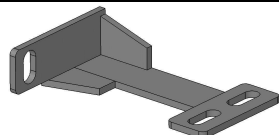
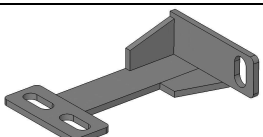
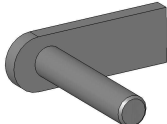
<p>1. Rura przednia (szt. 1) Bullbar (1 pc.) Передняя дуга (шт.1) Frontbügel (st.1)</p>	
<p>2. Zamocowanie prawe (szt. 1) Right attachment (1 pc.) Крепление правое (шт.1) Montage rechts (st.1)</p>	
<p>3. Zamocowanie lewe (szt. 1) Left attachment (1 pc.) Крепление левое (шт.1) Montage links (st.1)</p>	
<p>4. Szpilka M12x60 (szt. 2) Skewer M12x60 (2 pcs.) Шпилька M12x60 (шт.2) Stecknadel M12x60 (st.2)</p>	

Wykaz elementów łącznych:**Connecting components:****Список соединительных элементов:****Die Auflistung der Elemente:**

<p>Śruby (szt.) Screws (pcs.) Болты (шт.) Schrauben (st.)</p>	<p>M10x35 – (4) M12x60 – (2) (Szpilka - skewer)</p>	<p>Nakrętki (szt.) Nuts (pcs.) Гайки (шт.) Muttern (st.)</p>	<p>M10 – (4) M12 – (2)</p>
<p>Podkładki (szt.) Washers (pcs.) Шайбы (шт.) Unterlegscheiben(st.)</p>	<p>Ø 11 – (8)–XL Ø 13 – (2)–XL</p>	<p>17 46 Nm 19</p> 	

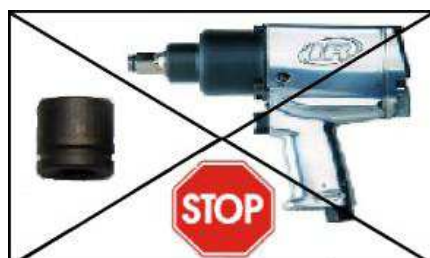

Czas montażu
Fitting time
Время монтажа
Montagezeit



1 h

UWAGA: Folię usunąć dopiero po montażu!

ATTENTION: Foil remove after fitting!

ВНИМАНИЕ: Целлофан снять только после завершения монтажа!

HINWEIS: Die Folie soll erst nach der Montage entfernt werden!

Montaż osirowania / Bullbar fitting / Монтаж защиты/ Montage der Schwellerrohre
T5-R0070-05

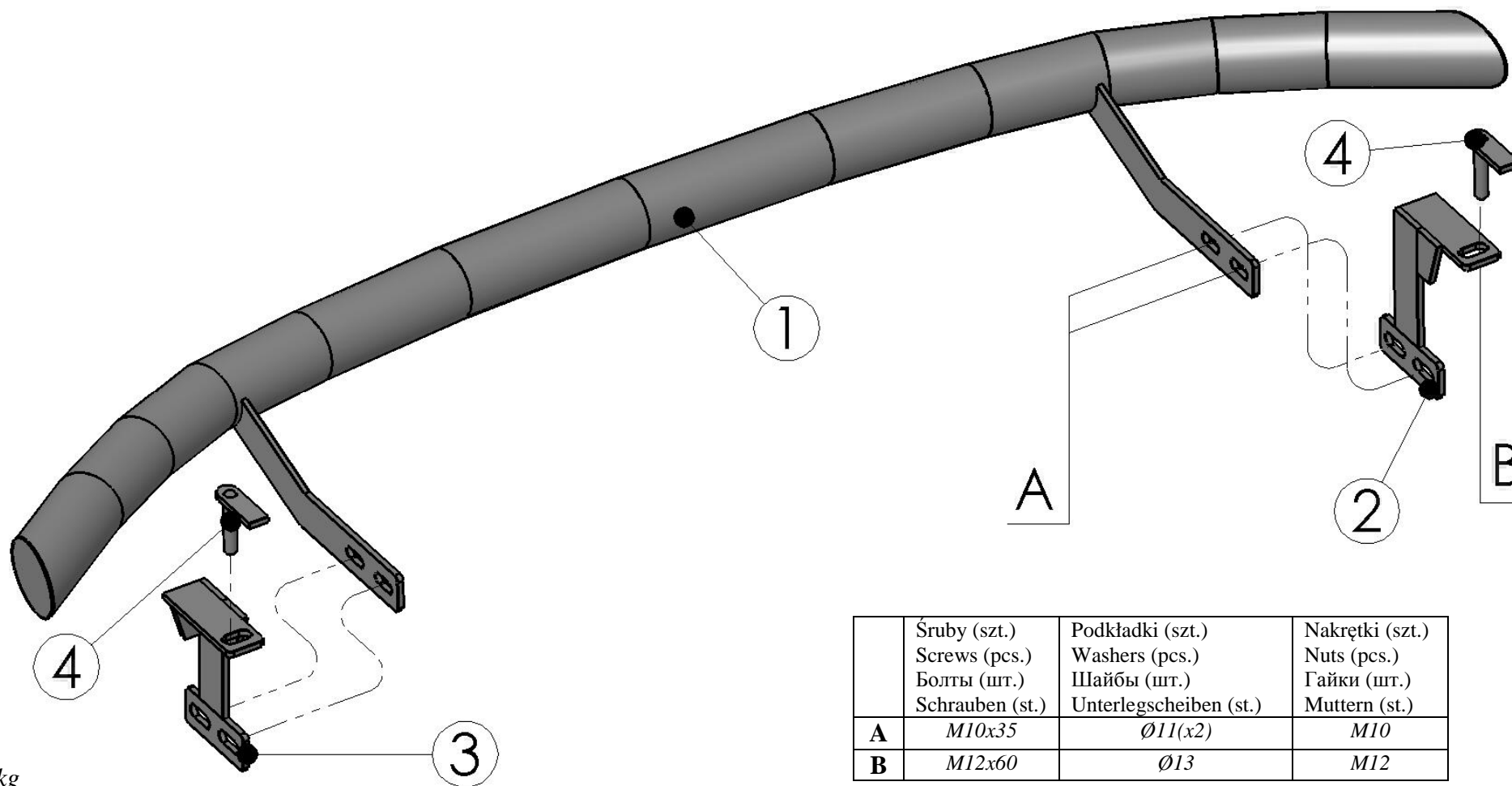

	Śruby (szt.) Screws (pcs.) Болты (шт.) Schrauben (st.)	Podkładki (szt.) Washers (pcs.) Шайбы (шт.) Unterlegscheiben (st.)	Nakrętki (szt.) Nuts (pcs.) Гайки (шт.) Muttern (st.)
A	M10x35	Ø11(x2)	M10
B	M12x60	Ø13	M12

B- szpilka / Skewer/ шпилька/ Stecknadel

*Lewa część orurowania / Left attachments / Левая часть защиты /
Linke Seite des Frontschutzbügels*

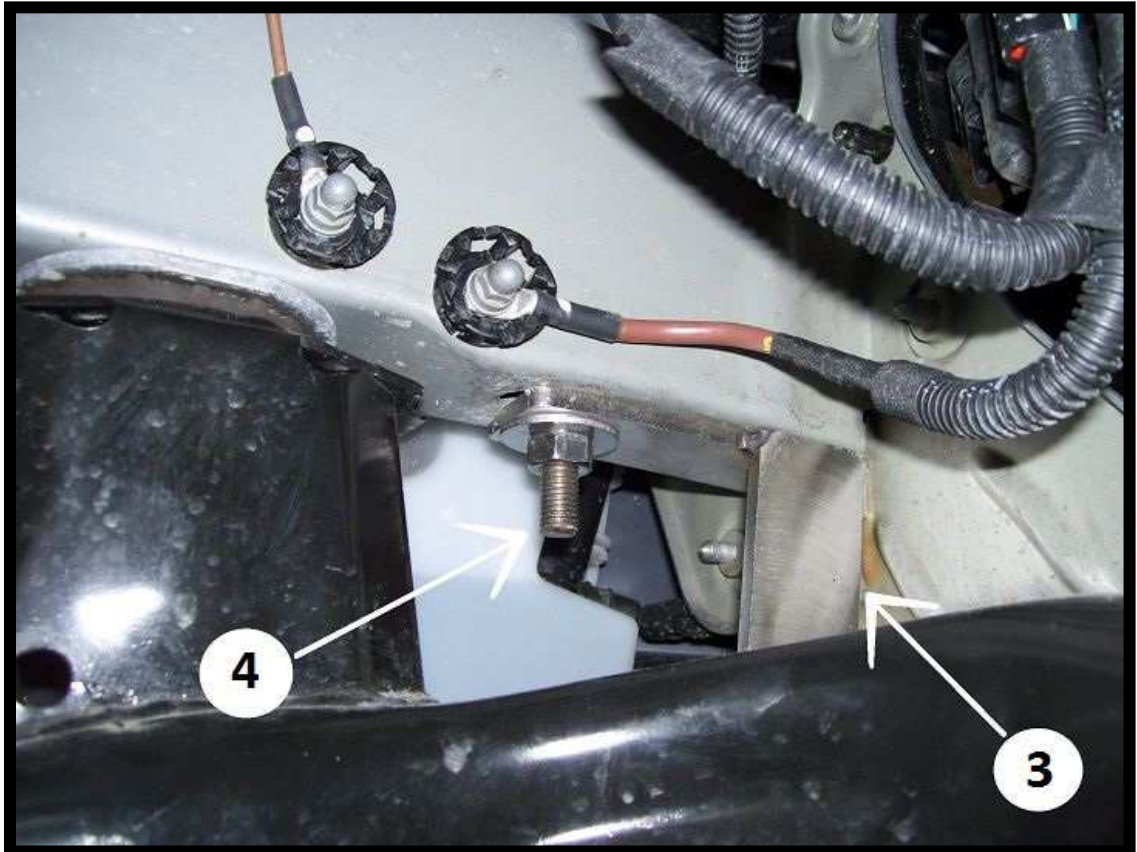



Prawa część orurowania / Right attachments / Правая часть защиты / Rechte Seite des Frontschutzbügels



